

**LEAPERS<sup>®</sup>, INC.**

USER MANUAL



USER MANUAL

**DOT SIGHTS**

**MODEL NO.:**  
**SCP-TDSDQ**  
**SCP-TDTDQ**

Windage/Elevation  
Premium Zero Lockable/  
Resettable Target Turrets

Front Integral  
Sunshade

Rear  
Integral  
Sunshade

Quick Detachable Lever  
Lock Mount Base  
Pat. 8397421

Red/Green Illumination  
Adjustment Rheostat

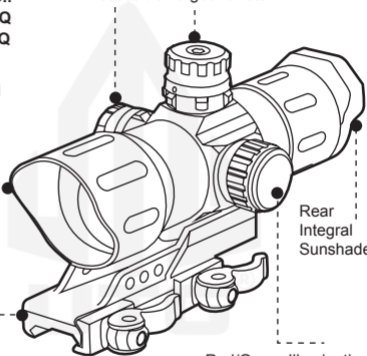

**MODEL NO.:**  
**SCP-DS3068W**

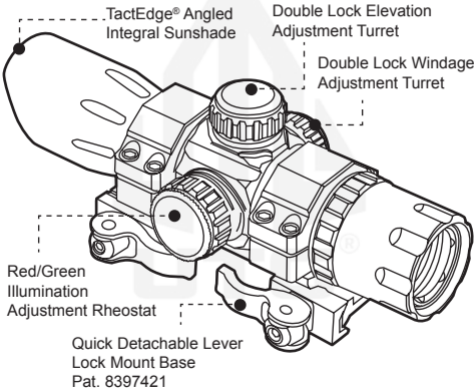

**MODEL NO.:**  
**SCP-DS3840W**  
**SCP-DS3840TDQ**

Double Lock Windage  
Adjustment Turret

TactEdge® Angled  
Integral Sunshade

Quick Detachable  
Lever Lock Mount Base  
Pat. 8397421



Double Lock Elevation  
Adjustment Turret

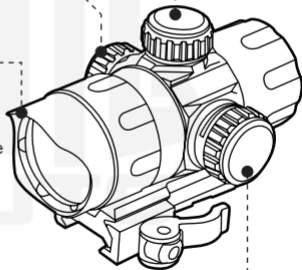

Red/Green Illumination  
Adjustment Rheostat

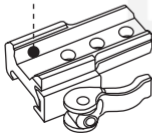

**MODEL NO.:**  
**SCP-DS3039W**

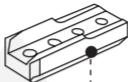

Riser

Double Lock Windage  
Adjustment Turret

Double Lock Elevation  
Adjustment Turret

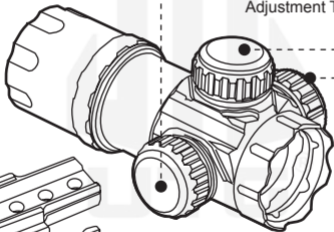

Red/Green  
Illumination  
Adjustment  
Rheostat

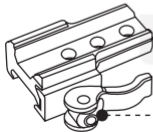

Quick Detachable Lever Lock Mount Base  
Pat. 8397421

**MODEL NO.:**  
**SCP-DS3028W**

Double Lock  
Elevation  
Adjustment  
Turret

Red/Green  
Illumination  
Adjustment  
Rheostat

Double Lock  
Windage  
Adjustment Turret

Quick Detachable  
Lever Lock Mount Base  
Pat. 8397421

TactEdge® Angled  
Integral Sunshade

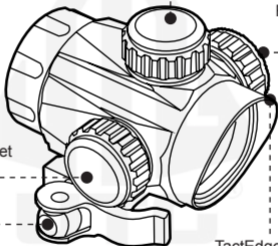

**MODEL NO.:**  
**SCP-DS3026W**

Click  
Adjustable  
Elevation  
Adjustment  
Knob

Red/Green  
Illumination  
Adjustment  
Rheostat

Click  
Adjustable  
Windage  
Adjustment  
Knob

Quick Detachable  
Lever Lock Mount Base  
Pat. 8397421

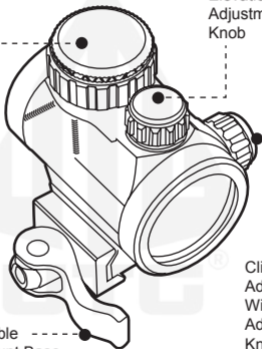

**MODEL NO.:**  
**SCP-RG40CDQ**  
**SCP-RG40SDQ**

Red/Green Illumination  
Adjustment Rheostat

Click  
Adjustable  
Elevation  
Adjustment  
Knob

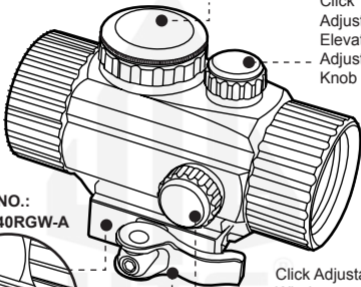

**MODEL NO.:**  
**SCP-RD40RGW-A**



Locking  
Nut

Click Adjustable  
Windage  
Adjustment Knob

Integral Picatinny/Weaver  
Mount Base

Quick Detachable  
Lever Lock Mount Base  
Pat. 8397421



## A. Mount/Riser Installation:

Dot Sight models with bi-directional and height adjustable QD mount bases provide several different mounting configurations. Both the riser and the QD mount base can be installed either towards or away from the muzzle should you prefer a forward or aft offset. Both can also be centered should your preference not require an offset. Removing the riser and directly installing the QD mount base to the dot sight will lower the dot sight height. Other dot sight models come with a fixed height and/or integral mount base.

1. Align the riser with the mating base of the dot sight in a position of your preference, making sure the screw holes of the riser and mating base are indexed properly. Install and fasten the two screws until the riser is fully secure. Mounting the QD mount base to the riser or directly to the dot sight follows the same procedure as shown in Fig 1. Some dot sight models have a fixed integral mount base which is not removable.
2. For dot sights equipped with a ring-type mount base, remove ring top screws using the included tool in order to remove the top half of the rings. Once they are removed, place the dot

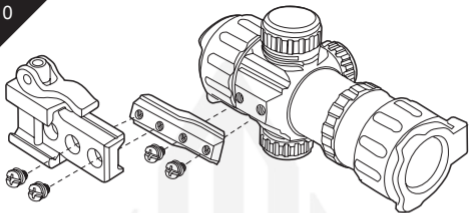
**Fig 1****Fig 2**

sight within the mount and place the top half of the rings back and over the dot sight as shown in Fig 2. Make sure your dot sight is leveled correctly and proceed to reinstall the ring top screws evenly and securely in a cross-torque pattern as shown in Fig 3.

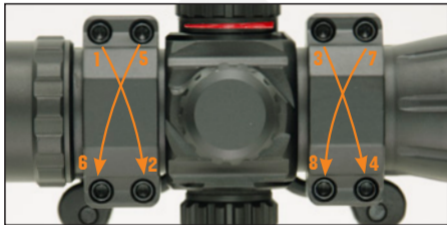

*Fig 3*

**NOTE:** Some dot sight models may come with both screws and washers. Always install and fasten the screws along with the washers during installation if present.

## **B1. Installation onto Picatinny Rail: (For Dot Sights with QD Mounts)**

1. Turn the Cam Lever in the direction that widens the spring loaded locking plate and provides the needed mounting clearance for installation as shown in Fig 4. Make sure the QD mount base's cross bolt seats properly within the Picatinny slot.
2. Turn the Cam Lever in the opposite direction to close the spring loaded locking plate, locking the QD mount base to the Picatinny rail as shown in Fig 5.
3. Should the QD mount base be loose, unlock the Cam Lever and use the included Allen wrench to adjust the Hex Screw found within the Cam Lever Housing. Turning the Hex Screw clockwise will increase the locking plate tension by decreasing the clamping width.
4. Should the Cam Lever not fully

*Fig 4**Fig 5*

turn into the locked position and you feel heavy resistance, the locking plate tension is too high.

Use the included Allen wrench to adjust the Hex Screw counterclockwise to decrease the locking plate tension by increasing the clamping width.

5. The optimal tension is achieved when the locking plate first makes contact with the Picatinny rail while the Cam Lever still has enough travel left for you to turn the Cam Lever to the locked position.

**CAUTION:** Always double check to ensure that all attachment screws are securely tightened before use.

## **B2. Installation onto Picatinny Rail: (For Dot Sights with Locking Nuts)**

1. Place the mounting base at your preferred position along the Picatinny rail of the firearm.
2. Tighten each locking nut with a screwdriver or coin as shown in Fig 6 until the dot sight is secured onto the Picatinny rail.



*Fig 6*

## C. Battery Installation:

1. The battery is housed inside the Red/Green Illumination Rheostat.
2. With one hand, firmly hold the Rheostat's housing in place while simultaneously unscrewing the battery cap with your other hand as shown in Fig 7.
3. Place the battery within the Illumination Rheostat housing with the + side facing upward.
4. Screw the battery cap back on until tight using the same method in Step. 2.



*Fig 7*

## D. Power On/Off and Brightness Adjustment:

Turn the Rheostat to turn on the dot sight's illumination and select the color and brightness desired. Please note that two different rheostat styles are found in our series of Dot sights.



*Fig 8*

- 1. Color Coded/Numbered Rheostat:** the white dot on the left side of the dot sight indicates the current illumination setting the dot sight is set at. The larger the number it is set on, the brighter the illumination will be and vice versa as shown in Fig 8. The color of the numbers indicates what color the illumination will be. To turn off the dot sight illumination set the white dot to either the "R" or the "G".
- 2. Color Coded/Fine Adjustment Rheostat:** the white dot on the left side of the dot sight indicates the current illumination setting the dot sight is set at as shown in Fig 9. The red and green bands indicate what color the illumination will be. The increasing and decreasing widths of the bands indicate how bright the illumination will be with the widest width being the brightest and the narrowest width being the dimmest. To turn off the dot sight illumination, set the white dot to either the "R" or the "G".  
A close-up photograph of a black rheostat knob. A white dot is positioned on the left side of the knob's face. Below the knob, there are two curved bands: a red one on the left and a green one on the right. The width of these bands varies, indicating different illumination settings. The knob has a textured top surface with a small logo.
- 3. To conserve battery life, always turn the dot sight off when not in use.**

## E. Zero the Dot Sight:

Leapers dot sights come with one of the following adjustment turrets as shown below:

1. Click Adjustable Turret
2. Single Lock Turret
3. Double Lock Turret
4. Premium Zero Lockable/Resettable Target Turret



The purpose of zeroing the dot sight is to ensure that the illuminated dot is aligned with the impact point of your rifle. Before zeroing, read the following zeroing adjustment instructions carefully.

### **For Models with Click Adjustable Turrets:**

1. Unscrew and remove the turret caps.
2. Use a flat head screwdriver or coin to adjust for the windage and elevation.
3. Refer to the ZEROING section for further steps.

### **For Models with Double/Single Lock Turrets:**

1. Unscrew and remove the turret caps.



- Both the windage and elevation turrets are set to the locked position out-of-the-box.
- Locate the locking screw(s) found on each turret. Use the included small Allen wrench to unlock the screw(s) by turning counterclockwise  $\frac{1}{4}$  revolution or until the turrets can turn and make adjustments as shown in Fig 10 and Fig 11. **Do not over-loosen or remove the locking screw(s) as this may damage the turrets.**
- Refer to the ZEROING section for further steps.

*Fig 10**Fig 11*

### **For Models with Premium Zero Lockable/ Resettable Target Turrets:**

- Both the windage and elevation turrets are set to the locked position out-of-the-box.
- To unlock the windage and elevation turrets rotate the zero

locking rings at the base of the turrets counterclockwise 40-70 degrees until they stop as shown in Fig 12.



**Fig 12**

3. Refer to the ZEROING section for further steps.

**Zeroing— Make sure the turrets are unlocked before performing this step if applicable.**

1. Zeroing on a target
  - a. Using a bore sighter is recommended for initial zeroing
  - b. Place target at preferred zero distance.
  - c. Using a steadying device such as a bipod, shooting stand, bench rest, etc. turn on the dot sight, and if safe to

do so, fire a test group at the center of the target.

- d. If the POI(Point of Impact) of the test group is exactly in the center of the target then the POI is POA (Point of Aiming) and the dot sight is zeroed.
- e. If the POI is not POA, further adjustments need to be made. Follow the POI directions found on each turret and make the necessary adjustments accordingly to achieve POI is POA and the dot sight is zeroed.
- f. OPTIONAL: Zero Resetting (For Models with Zero Resettable Turrets)
  - i. If applicable, once the dot sight is zeroed and the Zero Locking Rings for both turrets are in the locked position, use the Allen wrench to turn the Zero Resetting Hex Screw 180-360 degrees counterclockwise. This will disengage the turrets.
  - ii. Once the turrets are disengaged, rotating the turret will not produce any adjustment and will have no impact on your zero. Focusing on one turret at a time, reset the "0" markings found on the turrets by slightly pulling up on the turrets until they can freely rotate. Reposition the "0" markings back to the center

position indicated by the white dot found on the side of each turret.

- iii. Once repositioned, unlock the Zero Locking Rings for both turrets and press the turrets down and back into their seated position.
- iv. Use the Allen wrench to turn back the Zero Resetting Hex Screw 180-360 Degrees clockwise until snug.

g. **OPTIONAL: Zero Locking**



**i. (For models with Double/Single Lock Turrets)**

If applicable, once the dot sight is zeroed, use the small Allen wrench to lock the turrets back down by turning clockwise  $\frac{1}{4}$  revolution until snug and the turrets can no longer make adjustments. Do not over torque the locking screws as this may damage the turrets. Screw the turret caps back on.

**ii. (For Models with Zero Lockable Turrets)**

If applicable, once the dot sight is zeroed, rotate the Zero Locking Rings found on both turrets clockwise 40-70 degrees until finger tight.

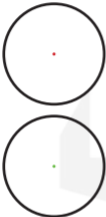
## F. Different Dot Sight Reticles:

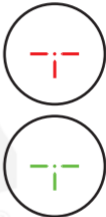
	Single Dot Reticle	Circle Dot Reticle	T Dot Reticle
Illustration			
Specs	<b>Dot size:</b> 4 MOA	<b>Dot size:</b> 4 MOA <b>Circle Dia.:</b> 62 MOA	<b>Center Dot Size:</b> 4 MOA <b>From Center Dot to Outer Ends of Post:</b> 40 MOA

## **G. Care and Maintenance:**

1. Take care not to drop or knock the dot sight once it is zeroed.
2. Maintain the metal surface of the dot sight by removing any dirt or sand with a soft brush so as to avoid scratching the finish.
3. Wipe the lens with a clean flannel cloth to keep it clean and dry. In order to avoid scratching the glass, ensure both the lens and cloth are clean. Do not use finger or finger nail to touch/clean lenses.
4. Store the dot sight in a cool dry place when not in use. Be careful to avoid contact with acid, alkaline or corrosive chemicals. Remove batteries from the dot sight if storing for a prolonged period of time.
5. Do not attempt to lubricate any part of the dot sight.
6. Do not disassemble the dot sight. Do not loosen or remove screws or parts. Any such or similar actions will void the warranty.

**CAUTION:** Viewing the sun can cause serious eye injury. Never look directly into the sun with this or any optics.

## **H. The Best Never Rest Warranty - Lifetime**

Leapers, Inc. warrants that all UTG & UTG PRO products conform to published specifications and are free from defects in material and workmanship. We will repair or replace defective products for the duration of the product's life span. Our dedicated and professional in-house customer service team will go above and beyond to make things right and provide the best in-class customer service experience you expect to receive.

Our warranty does not extend to products damaged from misuse, accidental damage, negligence, natural disasters/accidents, or unauthorized repair or alteration.

For warranty service, please submit your inquiry by visiting our customer service page on our website at [www.leapers.com](http://www.leapers.com) or give us a call at 734-542-1500. A Return Authorization Number (RMA) must be assigned before returning any products for warranty service.

WWW.LEAPERS.COM  
Explore  
More  
At



**32700 Capitol Street,  
Livonia, MI 48150, U.S.A.**

Tel:(734)542-1500

Fax:(734)542-7095

Email:office@leapers.com

MUO016061604